

PLEASE CALL IF YOU ARE MISSING ANY PARTS OR HAVE ANY QUESTIONS REGARDING THE SAFE OPERATION OF THIS PRODUCT. (574-848-7491 or 800-294-0671)

APPELEZ SI VOUS MANQUEZ N'IMPORTE QUELLES PIÈCES OU VEUILLEZ AYEZ TOUTES LES QUESTIONS CONCERNANT L'EXPLOITATION SURE DE CE PRODUIT. (574-848-7491 or 800-294-0671)

LLAME SI USTED ESTÁ FALTANDO CUALESQUIERA PIEZAS O TENGA POR FAVOR CUALQUIER PREGUNTA CON RESPECTO A LA OPERACIÓN SEGURA DE ESTE PRODUCTO. (574-848-7491 or 800-294-0671)

OPERATING INSTRUCTIONS

Before filling hopper, become familiar with the operation of this spreader.

- ⊕ Obtain proper setting for material to be used from the SETTING MATRIX included with this spreader.
- ⊕ Move stop bolt on rate gauge assembly to the proper setting.
- ⊕ While turning handle crank and walking forward, push control lever forward to the stop bolt. To stop, pull lever back to close flow holes while continuing to crank handle and walking forward.
- ⊕ When finished, empty any remaining material from hopper.
- ⊕ Thoroughly wash spreader and allow to dry before storing.
- ⊕ No oiling is necessary.

DIRECTIVES D'UTILISATION

Avant de remplir la trémie, familiarisez-vous avec le mode d'emploi de l'épandeur.

- ⊕ Consultez le TABLEAU DE RÉGLAGE afin de savoir lequel utiliser selon le type de produit que vous appliquez.
- ⊕ Placez le boulon d'arrêt au bon réglage sur le sélecteur.
- ⊕ En tournant le fanatique de poignée et en marchant en avant, le levier de contrôle de poussée envoie au verrou d'arrêt. S'arrêter, retenir le levier pour fermer des trous d'écoulement en continuant à lancer à la manivelle la poignée et en marchant en avant.
- ⊕ Lorsque vous avez terminé, videz complètement la trémie.
- ⊕ Nettoyez l'épandeur à fond et laissez-le sécher avant de le ranger.
- ⊕ Il ne nécessite aucun huilage.

INSTRUCCIONES DE FUNCIONAMIENTO

Antes de llenar la tolva, conviértase al corriente de la operación de este esparcidor.

- ⊕ Obtenga el ajuste apropiado para que el material sea utilizado de la TARIFA QUE FIJA LA CARTA incluida con este esparcidor.
- ⊕ Mueva el perno de la parada en el montaje de galga de la tarifa al ajuste apropiado.
- ⊕ Girando el mango arrancan con la manivela y andando avanzado, palanca de control de empuje avanzada al cerrojo de parada. Pararse, retirar la palanca para cerrar el flujo agujerea siguiendo arrancando con la manivela el mango y andando avanzado. Cuando está acabado, vacíe cualquier material restante de la tolva.
- ⊕ Lave a fondo el esparcidor y permita para secarse antes de almacenar.
- ⊕ No hay el engrasar necesario.

EarthWay® EV-N-SPRED

ASSEMBLY and OPERATING INSTRUCTIONS
for Model **3100** Broadcast Spreader

DIRECTIVES D'ASSEMBLAGE

et D'UTILISATION

pour Model **3100** Épandeur Centrifuge

INSTRUCCIONES de la ASAMBLEA y
de FUNCIONAMIENTO

para Modelo **3100** Sembrador o
Esparcidor

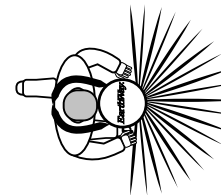

The settings furnished on the Rate Setting Chart are intended as a guide only. Variations in physical characteristics of material applied, walking speed, and roughness of ground surface may require slightly different spreader settings. Due to the above conditions, there is no warranty as to the uniformity of coverage actually obtained from the settings listed.

Les arrangements meublés sur le taux plaçant le diagramme sont prévus comme guide seulement. Les variations des caractéristiques physiques de matériel appliquées, de la vitesse de marche, et de la rugosité de la surface au sol peuvent exiger les arrangements légèrement différents d'écarteur. En raison des conditions ci-dessus, il n'y a aucune garantie quant à l'uniformité de l'assurance réellement obtenue à partir des arrangements énumérés.

Los ajustes equipados en la tarifa que fija la carta se piensan como guía solamente. Las variaciones en las características físicas del material aplicadas, la velocidad que camina, y la aspereza de la superficie de tierra pueden requerir ajustes levemente diversos del esparcidor. Debido a las condiciones antedichas, no hay garantía en cuanto a la uniformidad de la cobertura obtenida realmente de los ajustes enumerados.

3-2016 Pt. #52118

EarthWay[®] EV-N-SPRED

Earthway Products, Inc.

P.O. Box 547
Bristol, IN 46507
(574) 848-7491
800-294-0671

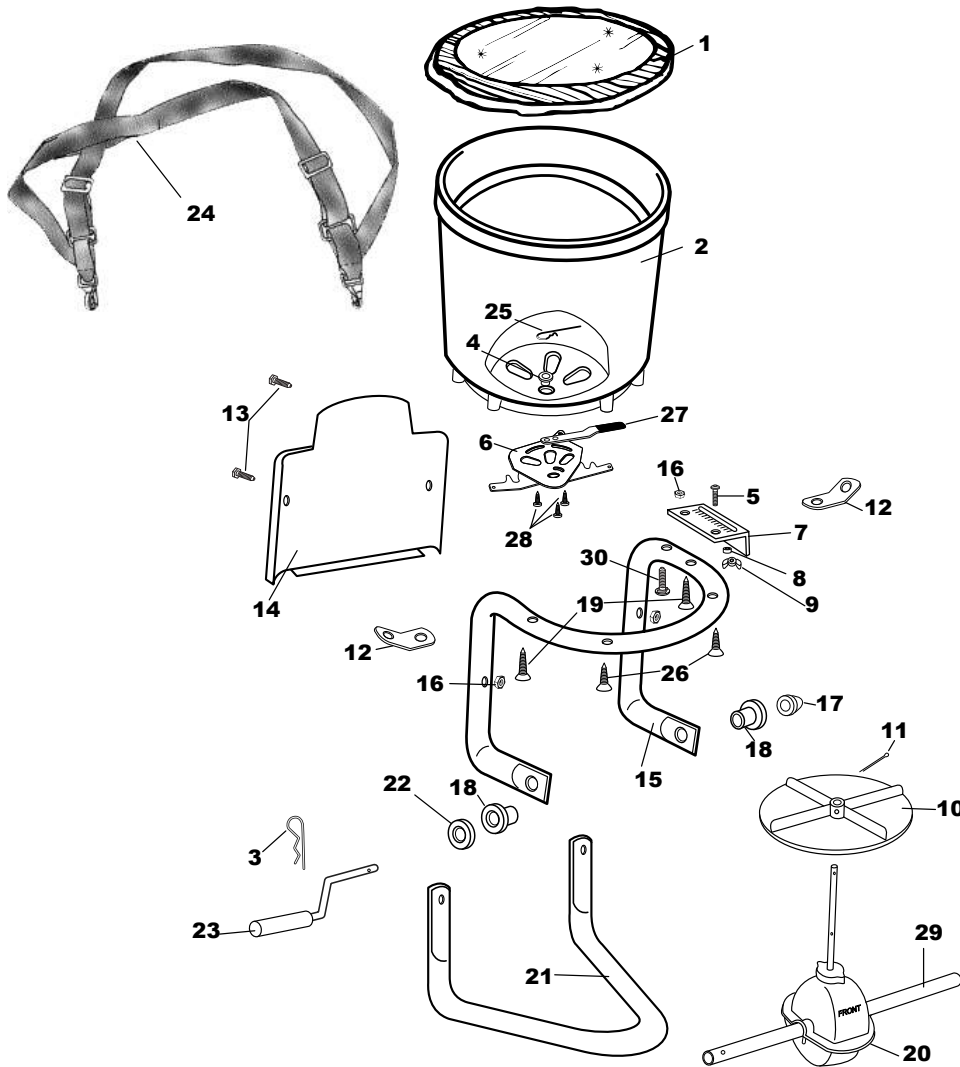

EarthWay[®] TOOLS

Verlaatweg 81 | 8243PS Lelystad | 088-118 65 50 | sales@earthwaytools.com | www.earthwaytools.com

3100 Parts List

Key #	Part #	Description	Key #	Part #	Description	Key #	Part #	Description
1	77000	HEAVY DUTY RAIN COVER	11	36105	1/8" X 1 1/4" COTTER PIN S.S.	21	23600	STAND
2	13103	HOPPER	12	44226	HARNES CLIP	22	34103	1"OD X 17/32"ID X 1/32" WASHER
3	33110	HAIR PIN CLIP #214 ZINC	13	37101	1/4-20 X 1 1/2" CARRIAGE BLT	23	60124	HANDLE CRANK ASSEMBLY
4	12220	HOPPER BUSHING	14	12188	BELLY GUARD	24	60121	HARNES ASSEMBLY
5	37103	#10-24 X 3/4" CARRIAGE BOLT	15	23103	FRAME	25	33117	AGITATOR
6	60128	LEVER & SHUT OFF ASSEMBLY	16	32100	1/4-20 HEX NUT ZINC	26	31108	#10 X 1 1/4" TYPE A FHPS
7	41262	FLOW GAUGE	17	12166	CRANK SHAFT CAP	27	19114	.125" X .75" X 2" GRIP BLK
8	12147	SPACER (PIVOT LINK)	18	12137	SPLIT BEARING	28	31138	#8 X 3/8" PMT #8 HD COARSE
9	32106	10-24 WING NUT ZINC	19	31128	#10 X 1 1/2" TYPE A FHPS	29	23608	CRANK SHAFT
10	12109	IMPELLER	20	60126	GEAR BOX ASSEMBLY	30	37109	1/4-20 X 1 1/4" CARRIAGE BOLT

5-YEAR LIMITED WARRANTY

Earthway Products, Inc. warrants this product free of defects in original workmanship and materials for a period of 5-years to the end user with the original purchase receipt. If a manufacturing non-conformance is found, Earthway Products, Inc. at its discretion will repair or replace the part(s) or product at no charge provided the failure is not the result of incorrect installation, mishandling, misuse, tampering, or normal wear and tear as determined by Earthway. Earthway at its discretion may require that the part(s) or product be returned along with the original purchase receipt at owners' expense for examination and compliance with the terms of this warranty. Do not return any product without first receiving authorization from Earthway Products, Inc. To seek remedy under this warranty, contact Earthway Products, Inc. at 574-848-7491, techsupport@earthway.com or write to Earthway Products, Inc. P.O. Box 547 Bristol, Indiana 46507 and describe the nature of the manufacturing defect. **SPECIFIC LIMITATIONS:** This warranty covers only the part(s) or product; any labor charges associated with repair or replacement of non-conformances are specifically excluded. Due to the corrosive nature of most fertilizers and ice melt products, Earthway Products, Inc. makes no warranty against and specifically excludes part(s) or product degradation or failure due to corrosion or its effects. Clean and dry your spreader thoroughly after each use, as a preventative measure, coat all metal parts (inside tubing) with a light oil or silicon spray.

Hand Crank Spreader Rate Setting Instructions

EarthWay[®]
EV-N-SPRED

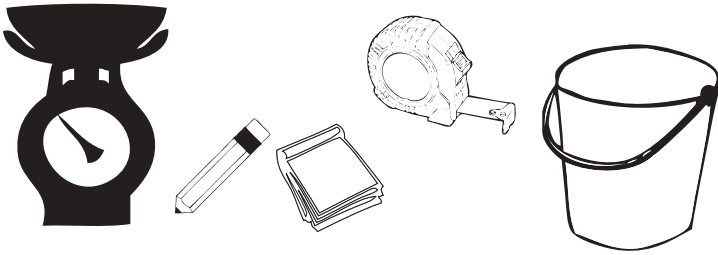

YOU WILL NEED:

- Tape measure
- Pencil & Pad
- Scale
- Bucket/container

To Calculate RATE SETTINGS: (Use the chart on page 2 to fill in numbers)

- ☑ Determine how much material is to be applied per 1,000 sq./ft. This is determined on the bag based on bag weight and total area of coverage if not directly stated on the bag the recommended number of pounds per 1,000 sq./ft.
- ☑ Measure off a distance of 50 feet, preferably on a paved surface such as a parking lot.
- ☑ Weigh out enough of the material to be applied to fill the bag/hopper at least half full.
- ☑ Record the weight for future use.
- ☑ With the unit positioned correctly for comfortable use, (on your left hip for 2700A/2750 or on your chest for the 3100/3200 models) and the bag/hopper at least half full of the material to be spread, position yourself far enough before the beginning of the 50 foot test area so that you will achieve the desired speed before you reach the starting line.
- ☑ Select the Setting Rate position that you feel would be an appropriate setting on the seeder/spreader (start in the middle).
- ☑ Start walking at a NORMAL pace cranking the handle so that it makes **one revolution for each step** with either your right or left foot to ensure the proper distribution rate.
- ☑ As you cross the starting line (of the 50 feet) move the rate lever to the open position against the stop.
- ☑ Continue from the starting line with the unit spreading the material. As you cross the finish line move the rate control lever to the closed position.
- ☑ Stop walking and measure the spread width and note it below.
- ☑ Return to the start point and empty the remaining material from the hopper into your weighing container and re-weigh.

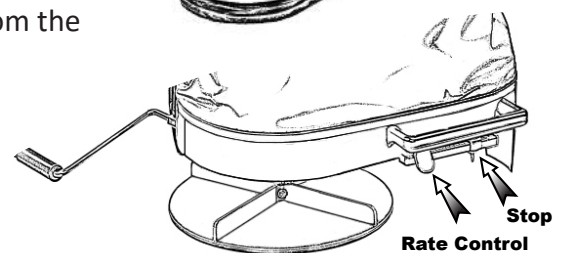
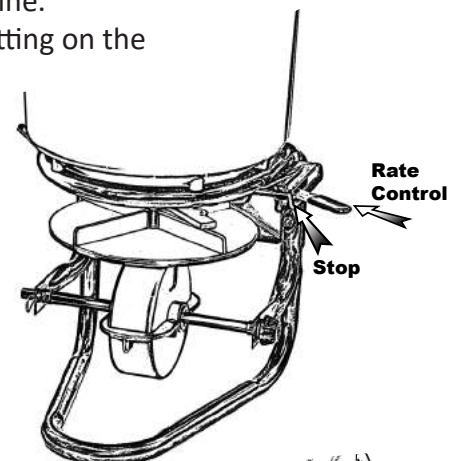
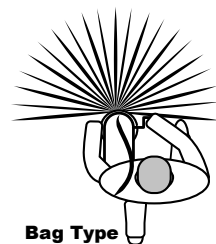
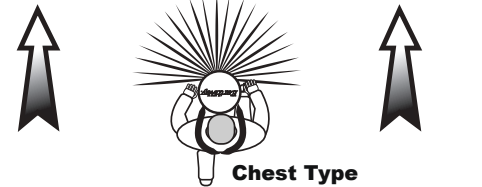
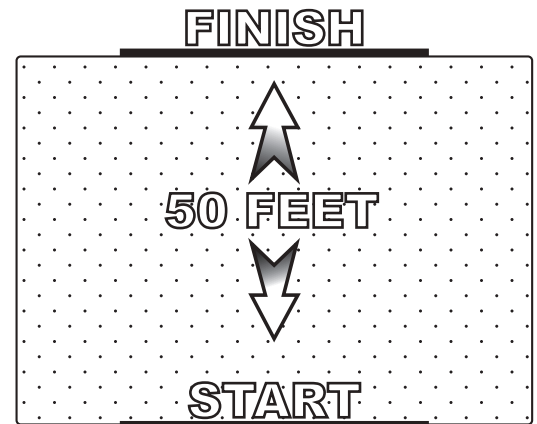

EarthWay[®]
TOOLS

Verlaanweg 81 | 8243PS Lelystad | 088-118 65 50 | sales@earthwaytools.com | www.earthwaytools.com

Spreading Paths

EarthWay®
EV-N-SPRED

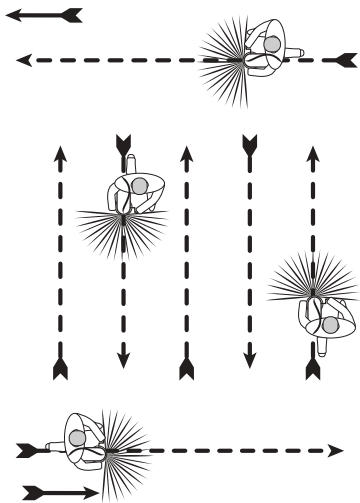

FULL Rate (one pass)

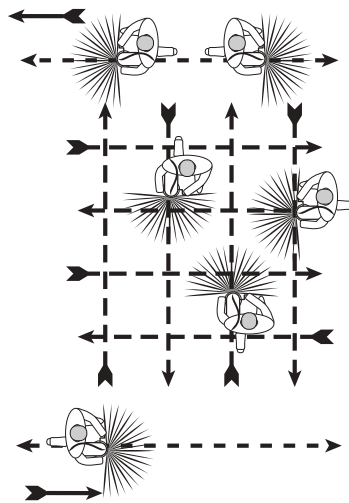

HALF Rate (two passes)

CHART

Desired Application Rate (lbs./1,000 sq. ft.) _____

To determine the desired application rate divide the area (sq. ft.) that the bag says it should cover, by the weight of the bag, and then multiply by 1,000. (Example: 5,000 sq. ft. / 25 lbs. = .005 x 1,000 = 5lbs. per 1,000 sq. ft.)

_____ Weight of Material Placed in Bag/Hopper
 - _____ Subtract the Weight of Material Left in Bag/Hopper
 = _____ Weight of Material Used

X _____ Multiply by the Width of Spread Area by Length (50 feet)
 = _____ Total Spread Area

Divide the Weight of Material Used by the Total Spread Area = _____ lbs.\sq. ft.

Multiply the lbs.\sq. ft. from above times 1,000 = _____ lbs.\1,000 sq. ft.

Compare the results of your test to the desired application rate.
 Adjust the rate setting stop accordingly and run through the test again.
 Repeat this process until you have achieved the desired application rate.

These settings are intended as a guide only. Variations in physical characteristics of material applied, brisk walking speed (3 mph.), and roughness of ground surface may require slightly different spreader settings. Due to the above conditions, Earthway Products, Inc. makes no warranty as to the uniformity of coverage actually obtained from the setting listed.

©2016 Earthway Products, Inc. All rights reserved. EarthWay® and EV-N-SPRED® are registered trademarks of Earthway Products, Inc.
 Use of trademarks are prohibited unless approved by Earthway Products, Inc. 1009 Maple Street
 Bristol, Indiana 46507.

EarthWay®
TOOLS

Verlaatweg 81 | 8243PS Lelystad | 088-118 65 50 | sales@earthwaytools.com | www.earthwaytools.com

